

BV 77 2011 MODEL

UNIT 1

ILLUSTRATED PARTS BREAKDOWN

From Serial Number: 31800560

Edizione 2011
Rev. A

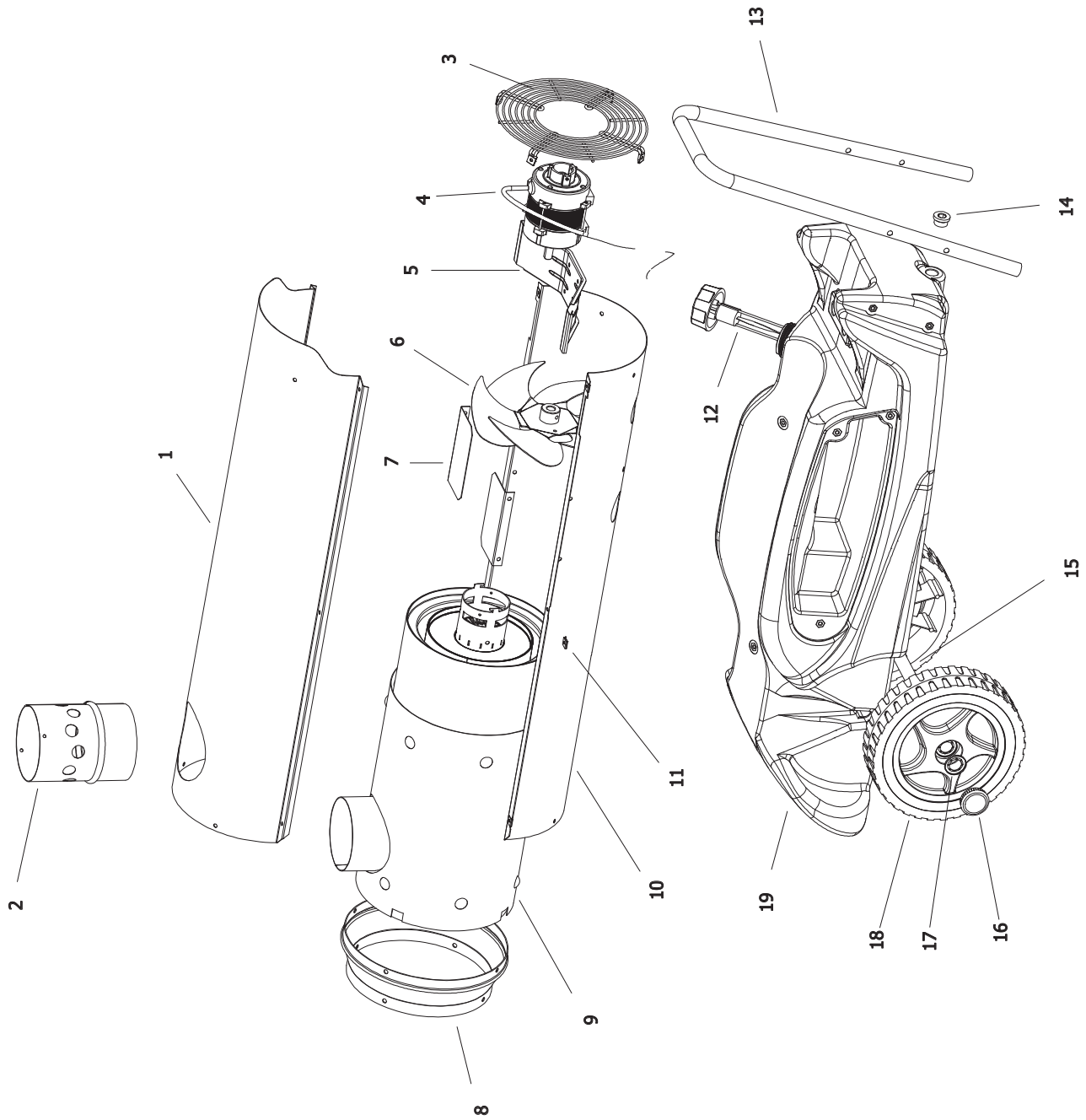

BV 77 2011 MODEL

UNIT 2

ILLUSTRATED PARTS BREAKDOWN

From Serial Number: 31800560

Edizione 2011
Rev. A

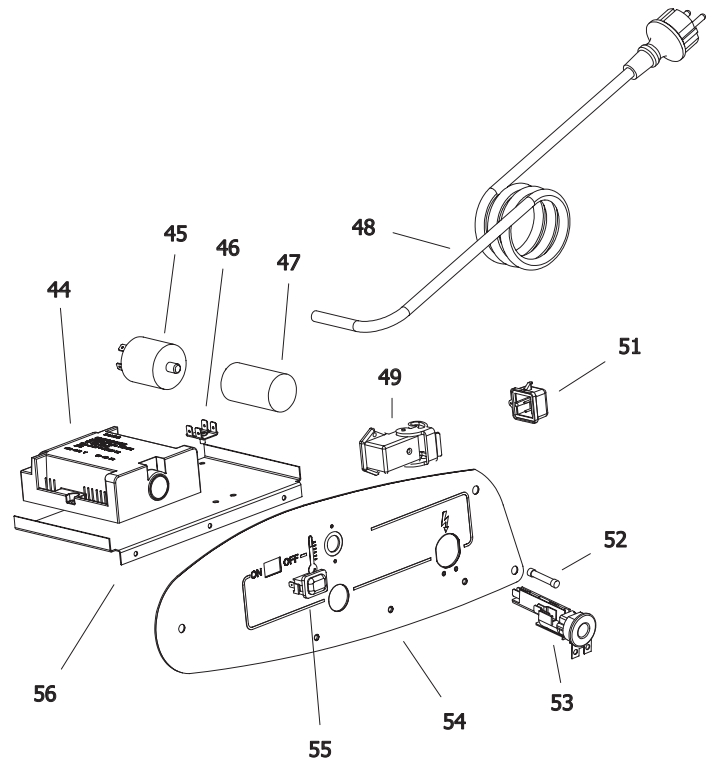
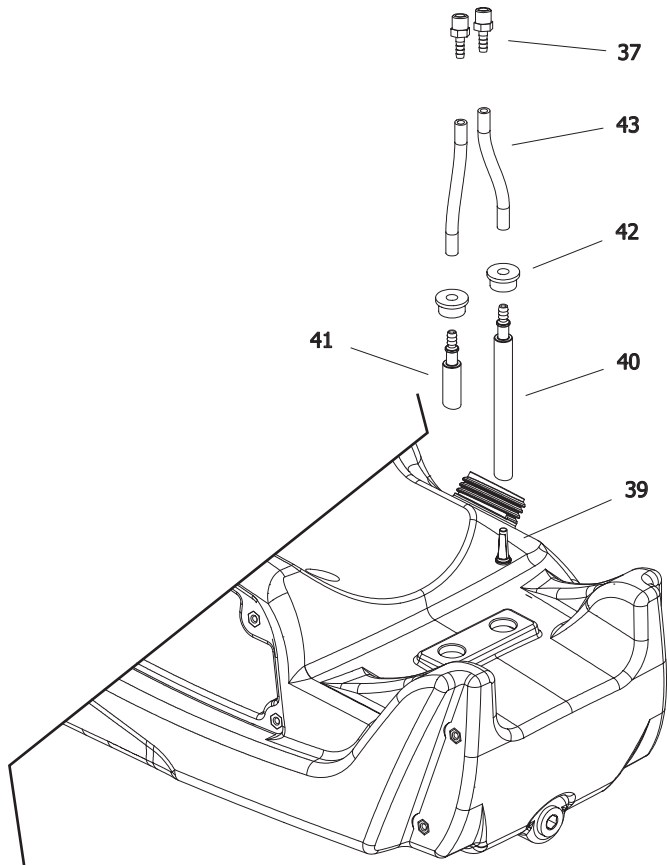
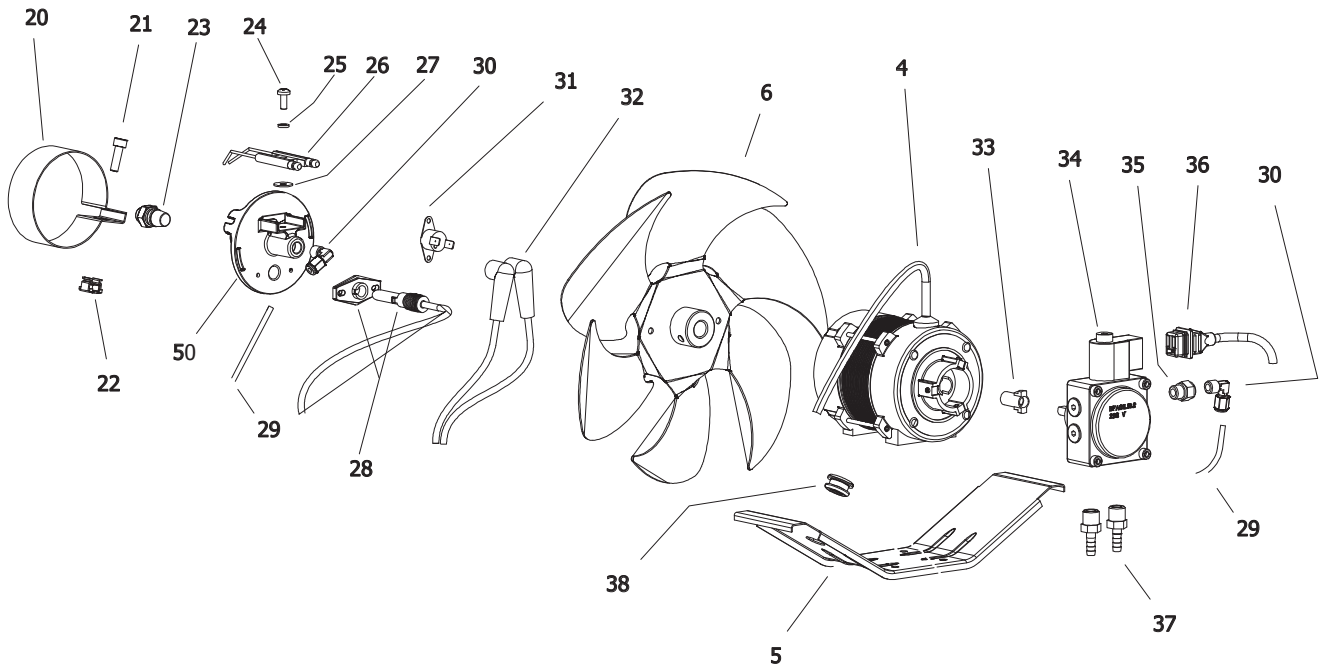

Pos.	Code NR	Description
1	4032.832	UPPER SHELL
2	4032.840	CHIMNEY
3	4032.836	GRID
4	4032.815	MOTOR
5	4032.835	MOTOR BRACKET
6	4032.814	FAN
7	4032.808	AIR FLAP
8	4032.838	OUTLET AIR CONE
9	4033.081	COMBUSTION CHAMBER
10	4032.834	LOWER SHELL
11	4104.170	CLIP NUT
12	4032.845	FUEL LEVEL PROBE
13	4032.811	HANDLES
14	4032.813	DRAIN PLUG
15	4032.809	AXLE
16	4111.480	WHEEL PLUG
17	4111.072	WHEEL HOLDER
18	4032.094	WHEEL
19	4033.037	TANK
20	4032.545	AIR REGULATION FLAP
21	4032.455	SCREW
22	4032.454	CAGE NUT
23	4031.536	NOZZLE
24	4110.363	SCREW
25	4110.393	WASHER
26	4032.396	BIFILAR ELECTRODE
27	4110.294	WASHER
28	4033.022	PHOTOCELL
29	4032.854	OIL SUPPLY PIPE
30	4161.140	ELBOW
31	4032.883	LIMIT THERMOSTAT
32	4032.885	HT CABLE
33	4111.081	COUPLING

Pos.	Code NR	Description
34	4032.789	PUMP
35	4161.501	NIPPLES
36	4032.905	POWER CORD SOLENOID SPOOL
37	4032.906	FITTING 1/4"
38	4032.947	CABLE PROTECTION
39	4110.356	FUEL FILTER
40	4110.355	FUEL LINE TANK-PUMP
41	4033.038	FUEL PIPE PUMP-TANK
42	4100.541	RUBBER BUSHING
43	4110.032	FUEL LINE
44	4033.017	IGNITION CONTROL ASSEMBLY
45	4032.771	POWER LINE RFI FILTER
46	4160.639	POP RIVET WITH TERMIN. 4 WAY
47	4032.816	CAPACITOR 6,3 μ f
48	4111.153	POWER CORD
49	4111.119	THERMOSTAT SOCKET
50	4033.042	BURNER FLANGE
51	4162.467	CAP FOR THERMOSTAT SOCKET
52	4032.850	FUSE (6,3X32) 15A
53	4111.038	STRAIN RELIEF
54	4032.823	ELECTR. COMPONENTS PANEL
55	4100.667	ON/OFF SWITCH
56	4032.897	ELECTR. COMPONENTS BASE